



HM Government

NHS

Test and Trace

How to test yourself for COVID-19



Easy read booklet

How to use a home-testing kit

About this booklet

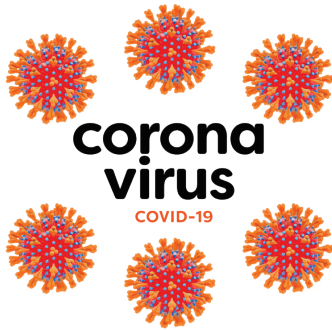

Coronavirus or **COVID-19** is an illness affecting people all over the world.

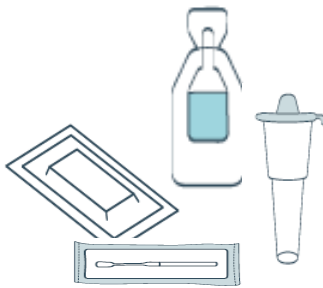

You can use a **home-testing kit** to find out if you have COVID-19. This booklet tells you how to use the kit.



A **home-testing kit** is a pack with everything you need to do the test yourself at home. You can ask an adult to help you with the test if you need to.



Some people have COVID-19 but don't know it. By using these tests we can find out who has COVID-19 and stop it spreading.

About the test



The test will take about 15 minutes.
The test result will be ready 30 minutes
after you finish the test.

The **result** means the answer to the
test, and tells you if you have
COVID-19.



You need to

- A. Get ready
- B. Get the test ready
- C. Take a sample with a swab
- D. Test the sample
- E. Get your result
- F. Tell us your result
- G. Throw your test kit away



This booklet tells you how to do the
test. You must read each part of
this booklet and do what it says.

Before you start the test



Keep the kit at normal room temperature. This means it should not be left in the sun, or in a fridge or freezer. Keep the kit away from children.



Use 1 kit for each person. You can only use each part of a kit once. Don't use the kit on animals.



If your nose is pierced on both sides, take the piercing out on 1 side. You will need to take a sample from the side with no piercing.



Don't eat or drink for 30 minutes before you use the kit. If you had a nosebleed in the last day, wait 24 hours before you use the kit.

A. Get ready

1



Read this booklet carefully. You can also watch a video showing how to take a test by clicking on this link

www.gov.uk/covid19-self-test-help

2



Get a flat area ready, like a table. Make sure it is clear, clean and dry.

3



Wash your hands for 20 seconds. Use soap and warm water, or hand sanitiser. Dry your hands.

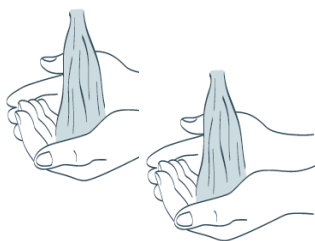

If you are doing more than 1 test, clean the table and wash your hands between each test.

4



Make sure you have everything you need. If anything is missing or broken do not use the kit.

From the kit

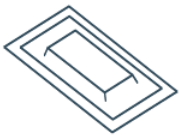

Test strip in a closed pack

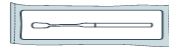

Swab in a closed wrapper



Extraction buffer **sachet**



Extraction tube

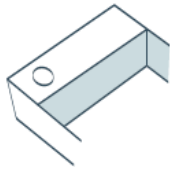

Extraction **tube holder** (part of the box)



Waste bag

From your home



a watch or clock



a mirror



tissues



hand sanitiser or soap and warm water

B. Get the test ready

5

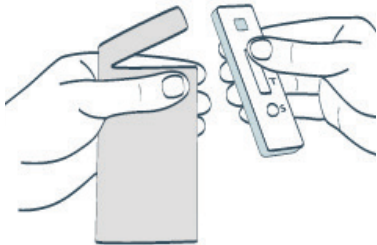

Take the **test strip** out of the closed pack. Put the test strip on your table, and the pack in the bin. You must start the test in the next 30 minutes.

6



Open the **sachet** carefully by twisting it or snapping it. Be careful not to spill any of the liquid in the sachet. Keep it away from your face.

7



Open the **extraction tube**. Slowly squeeze all of the liquid in the sachet into the tube. Try not to let the sachet touch the tube.

8

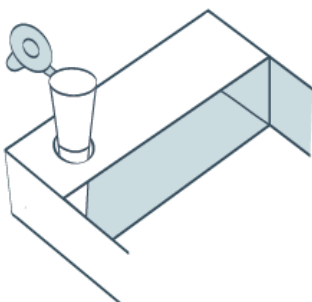

Put the extraction tube in the **tube holder**. This is a hole inside the box, it makes the tube stand up so you don't spill the liquid inside it.

9



Blow your nose into a tissue and throw the tissue in the bin.

10



Wash and dry your hands again. If you are helping someone else do a test, you must both wash your hands.

11

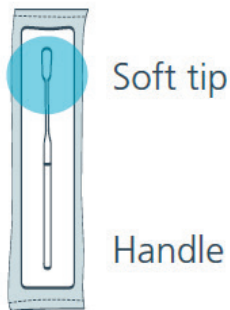

Pick up the **swab** in the closed wrapper. Make sure you know which end is the soft tip of the swab.

12

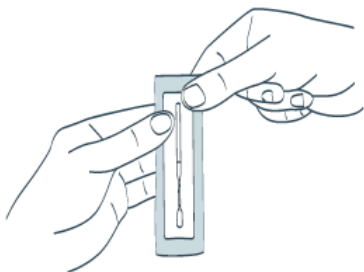

Open the closed wrapper and take out the swab by holding the handle. Never touch the soft tip with your hands.

C. Take a sample with a swab

Use this page for testing an adult



Hold the handle of the swab with your fingers. Open your mouth wide. Rub the soft tip of the swab over both tonsils 4 times.

Tonsils are soft pads at the back of your throat, 1 on each side. If you have no tonsils rub the swab on the sides of your throat.

Do not let the swab touch anything else, like your tongue or teeth.

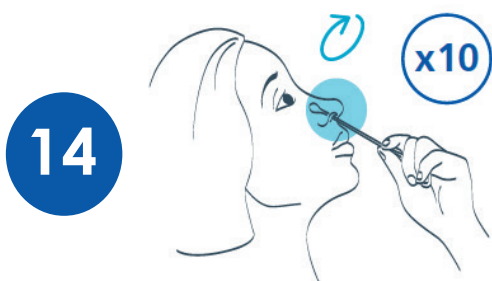

Take the swab out of your mouth and put it inside 1 side of your nose. Push it up until it stops. Rub the swab in a circle around the inside of your nose 10 times.

When you use the swab it might feel strange but it should not hurt.

Use this page for testing a child



If a child under 12 years old needs a test, an adult must do the test for them. It is good if the child can sit on someone's lap or hold someone's hand.



Tell the child what will happen. Ask them to blow their nose and cough into a tissue. Ask them to say 'Ahhh' to make it easier to see their tonsils. Stop the test if it hurts the child.

13

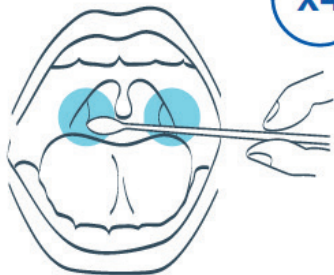

x4

Rub the soft tip of the swab over both tonsils 4 times. If it is too difficult to rub the swab on the tonsils, you can do inside both sides of the nose instead.

14

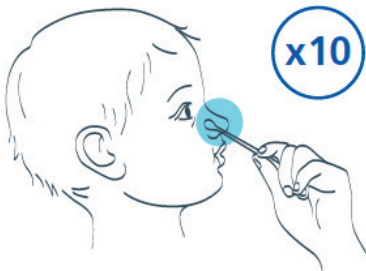

x10

Take the swab out of the mouth and put it inside 1 side of the nose. Push it up until it stops. Rub the swab around 1 side of the nose 10 times, or both sides 10 times if you could not swab the tonsils.

D. Test the sample

15

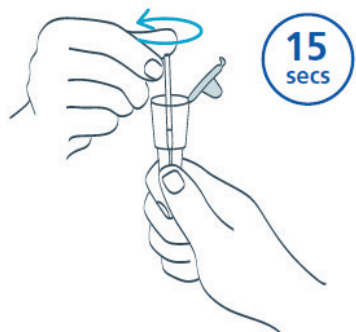

Pick up the **extraction tube** and open the lid. Put the soft tip of the swab inside the tube in the liquid. Stir the liquid with the swab and wipe the swab against the side of the tube for 15 seconds.

16

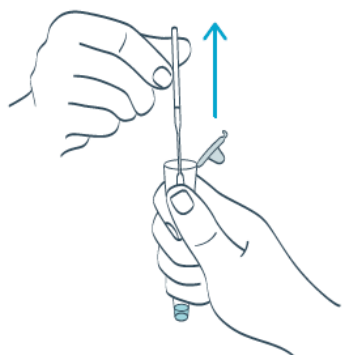

Take the swab out of the extraction tube. When you do this squeeze the tube onto the swab to help get all the liquid out of the swab. Put the swab in the **waste bag**.

17



Put the lid back onto the extraction tube. Make sure the lid is on tight so that it cannot leak.

18

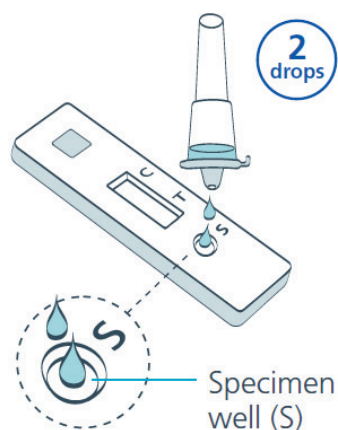

Turn the extraction tube upside down and squeeze 2 drops of the liquid onto the **test strip**. Make sure the drops are in the **specimen well** which is the hole next to the letter S.

19



Look at your clock or watch. You need to wait for 30 minutes for your test to be ready. Work out what time your test will be ready.

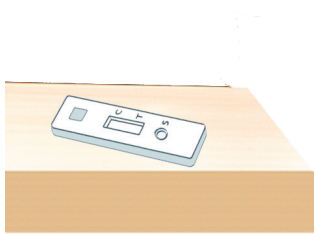

Don't move the test strip. It must stay flat and still.



While you wait, some lines might show on the test strip. Keep waiting as the lines might change.



After 30 minutes your test will be ready and you can read the result.

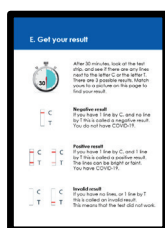

On the next page we will tell you what the lines mean and what your test result is.



E. Get your result

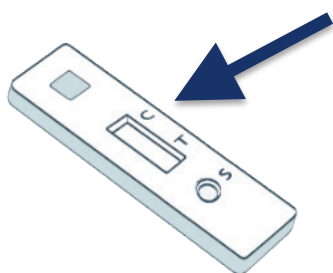

Look at your test strip and see if there are any lines next to the letter C or the letter T. There are 3 possible results. Match yours to a picture on this page to find your test result.



Negative result

If you have 1 line by C, and no line by T this is called a negative result. You probably do not have COVID-19. You can do another test if you get ill.



Positive result

If you have 1 line by C, and 1 line by T this is called a positive result. The lines can be bright or faint. You have COVID-19.



Void result

If you have no lines, or 1 line by T this is called an void result. This means that the test did not work. You need to do another test.

F. Tell us your result

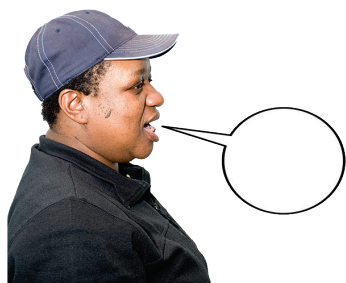

You must tell us the result of your test. This will help us learn more about COVID-19 and help more people.

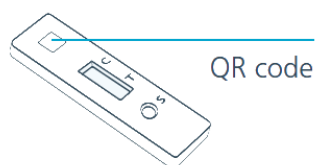

To tell us your test result you will need the QR code or the number on your test strip. The **QR code** is a pattern of dots that a computer or mobile can read.



You can tell us your result by going to this website

www.gov.uk/report-covid19-result



Or you can tell us your result by phoning us between 7am and 11pm.

In England, Wales and Northern Ireland call this number

119

In Scotland call this number

0300 303 2713

G. Throw your test kit away



After you have done the test, put all parts of the kit in the **waste bag**.



Put the waste bag in your bin.

What next

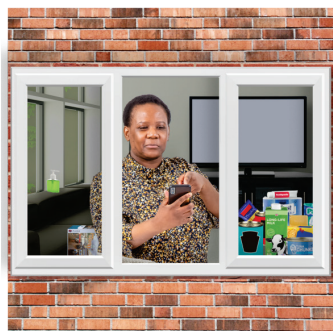

If you have COVID-19 you and everyone who lives with you must stay at home. You must follow the rules in the area where you live.



If you are not better after 7 days call **111**. If you are very ill call **999**.



If you need more help with the test visit this website
www.gov.uk/covid19-self-test-help

**The full version of this document is called
“Your step-by-step guide for COVID-19 self-testing”
Please read the full document for more information**